

0 Vertices Above Isosurface

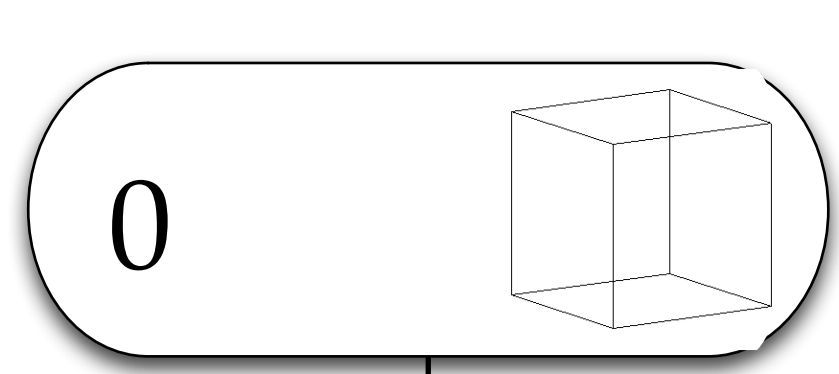

1 Vertex Above Isosurface

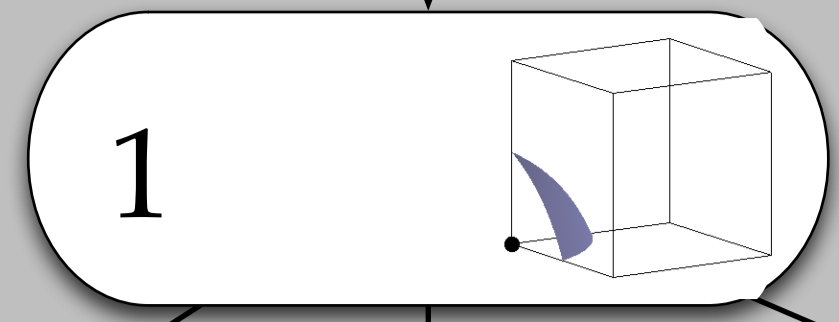

2 Vertices Above Isosurface

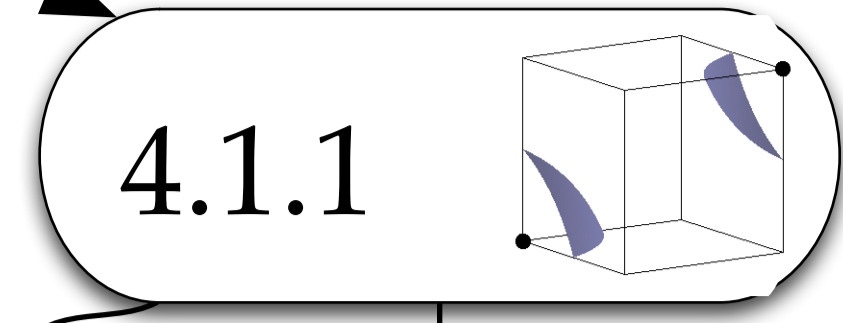
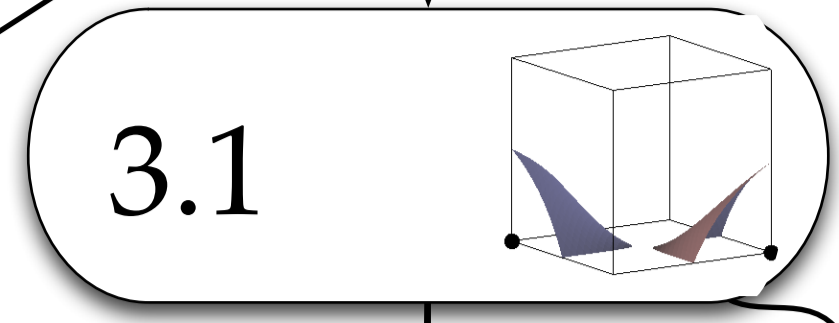
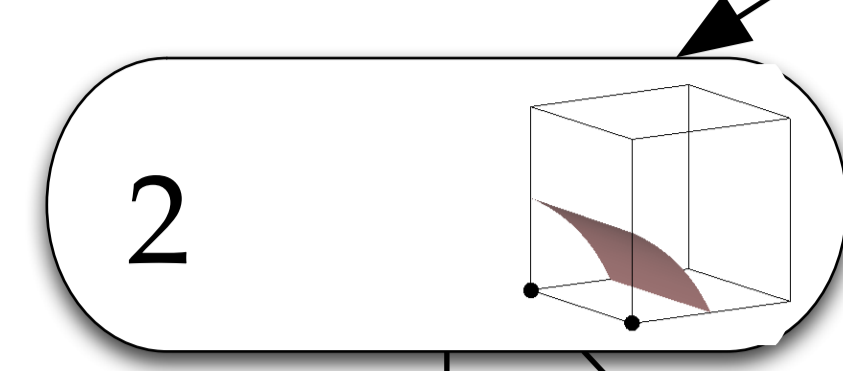

3 Vertices Above Isosurface

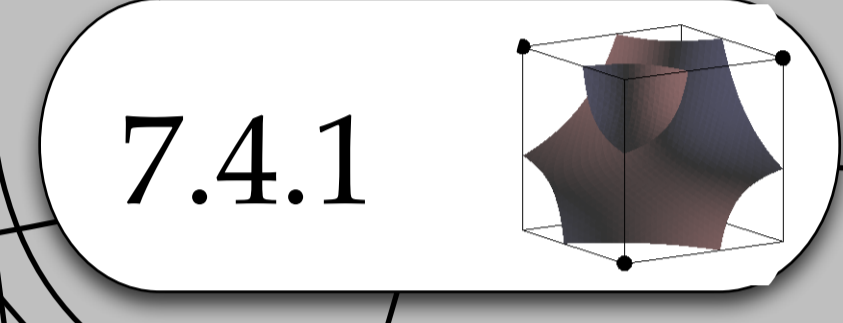
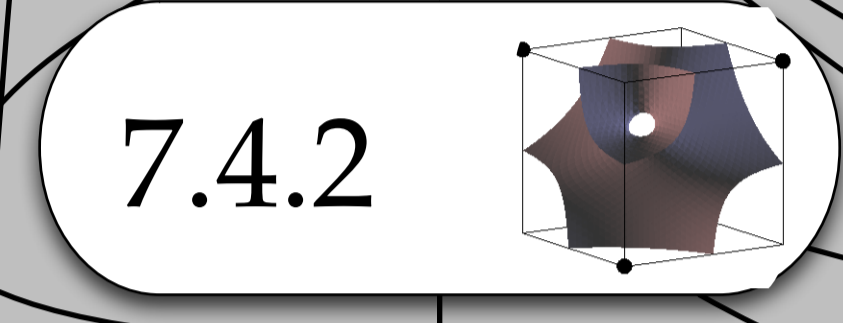
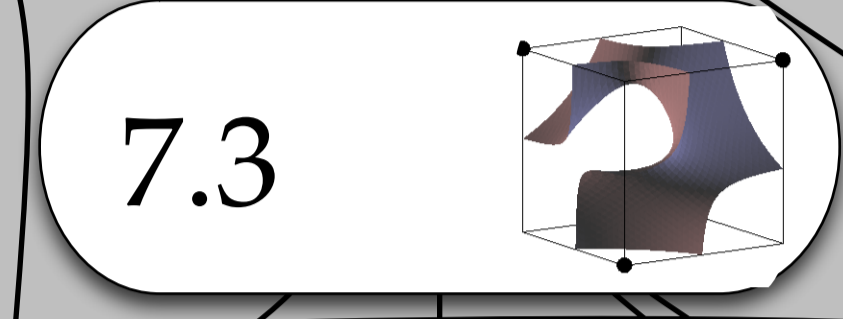
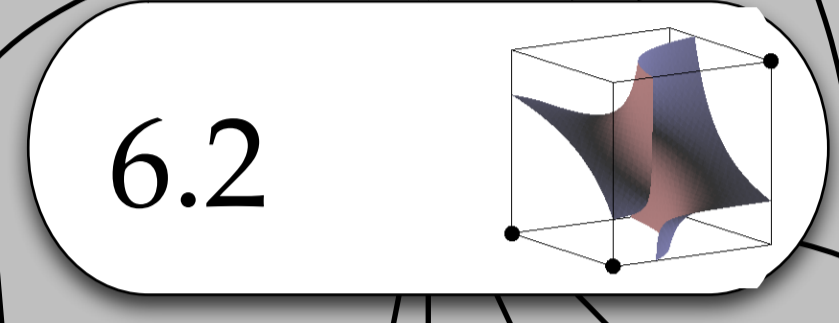
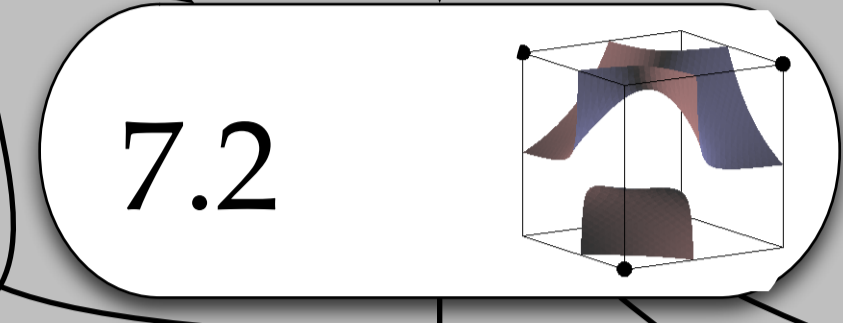
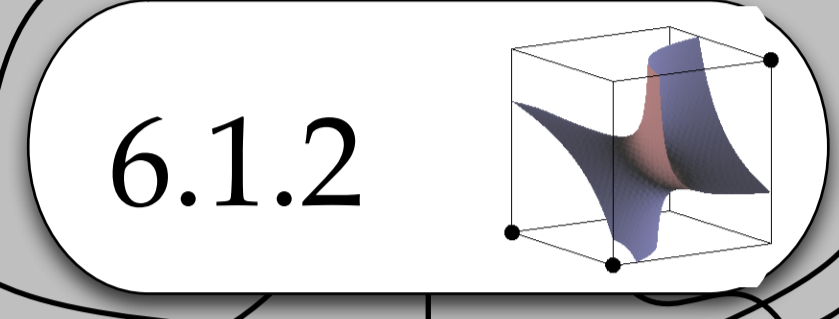
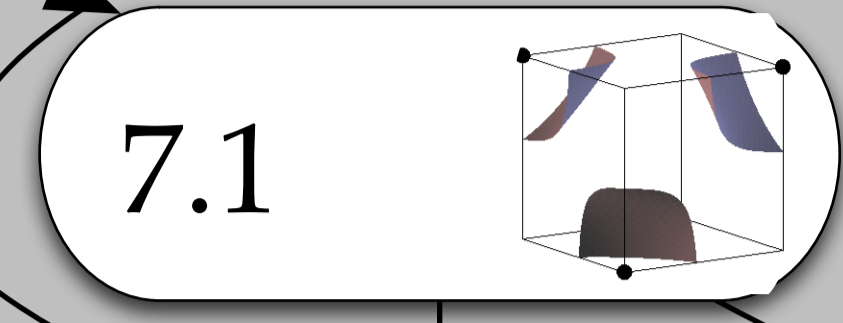
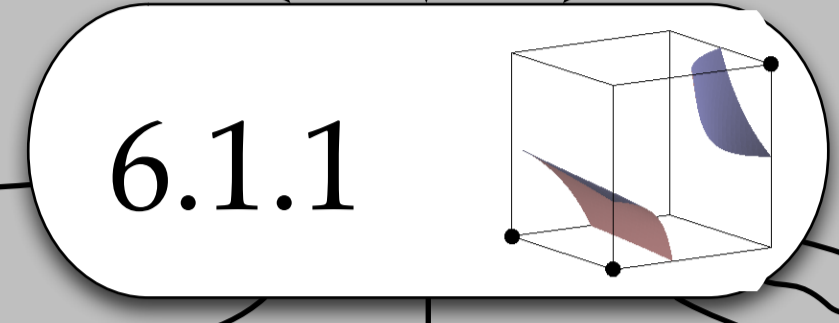
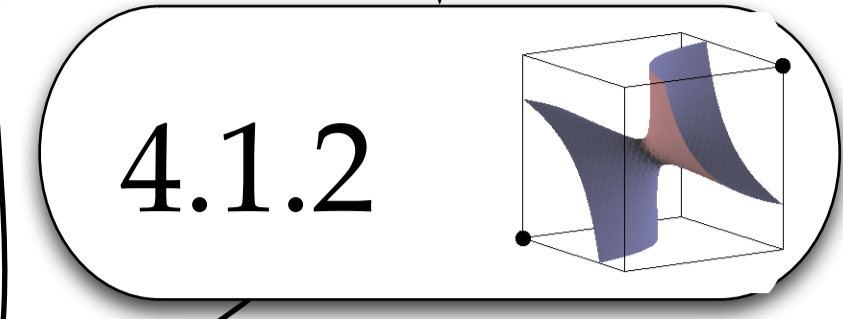
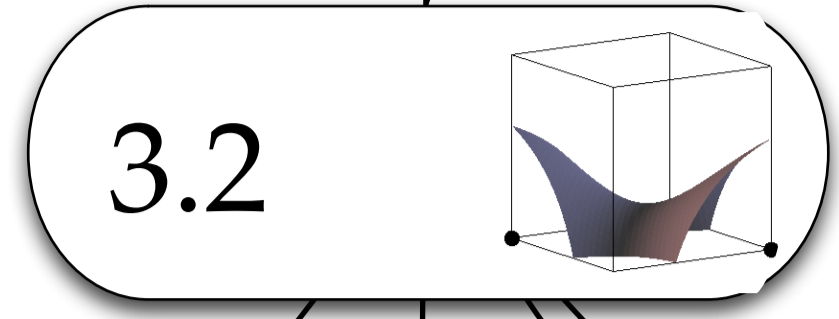
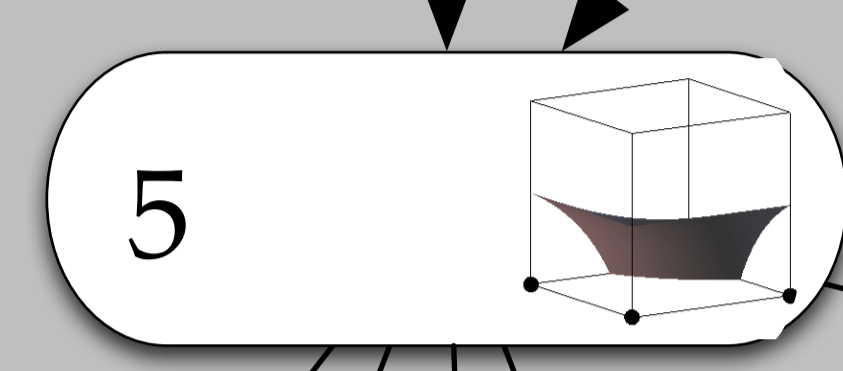

4 Vertices Above Isosurface

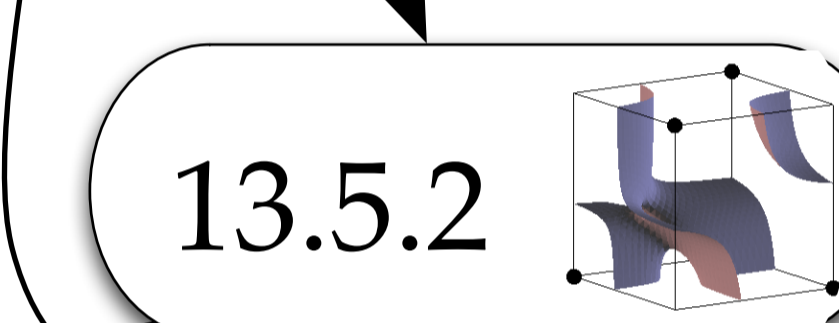
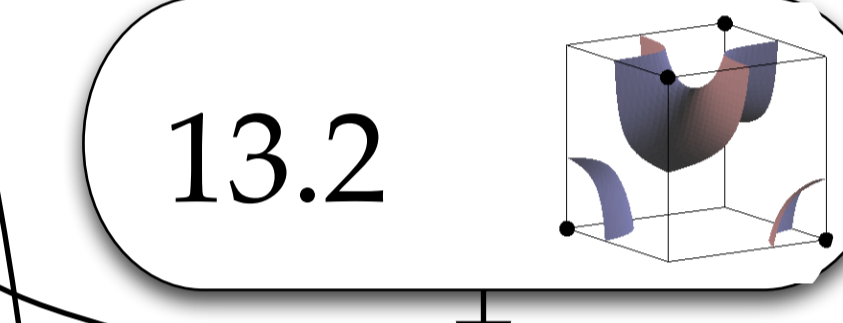
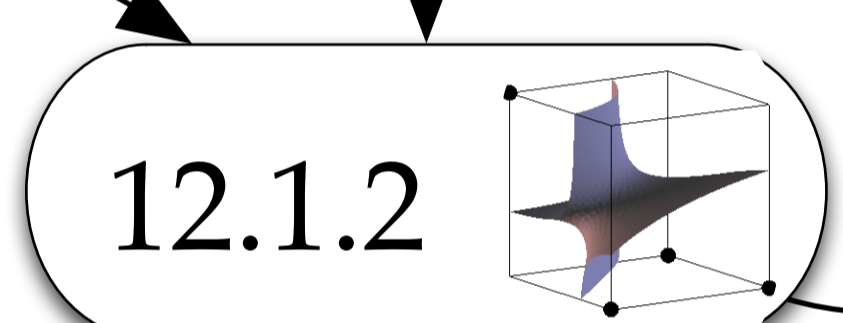
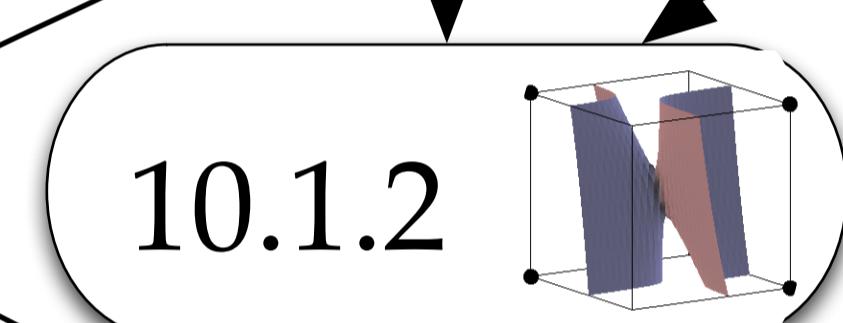
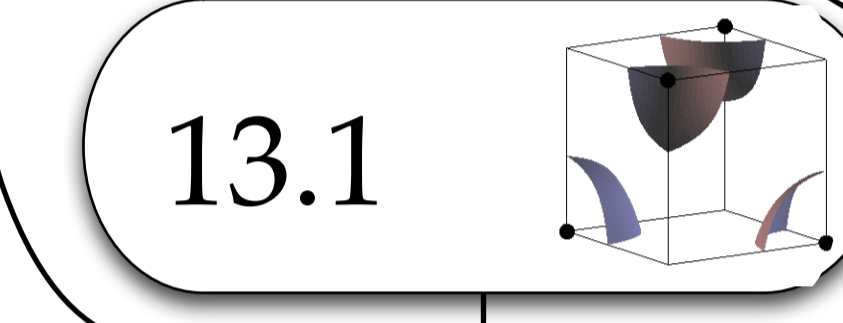
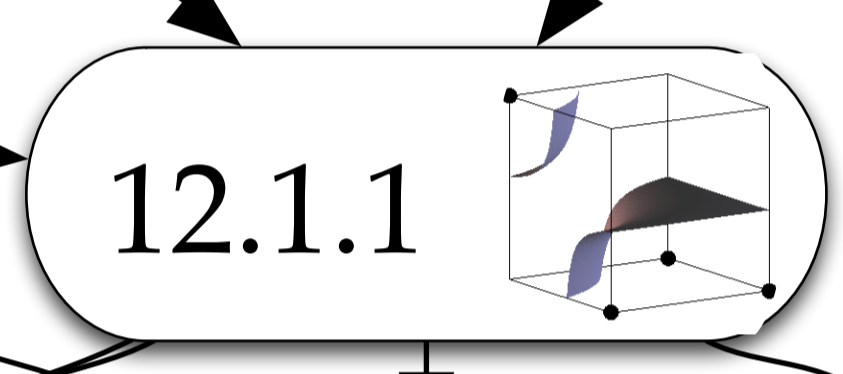
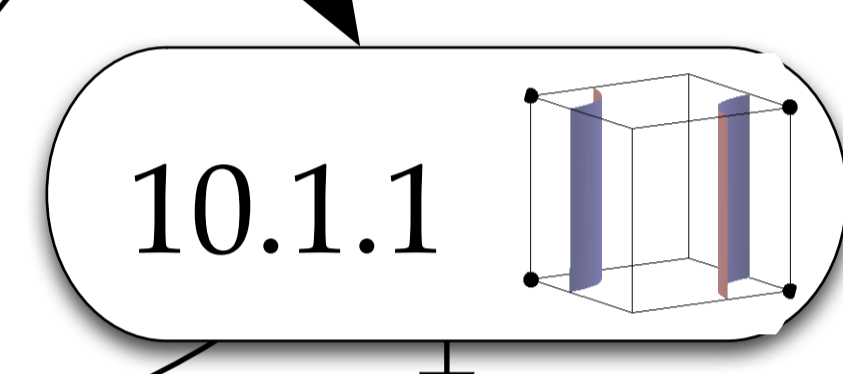

5 Vertices Above Isosurface

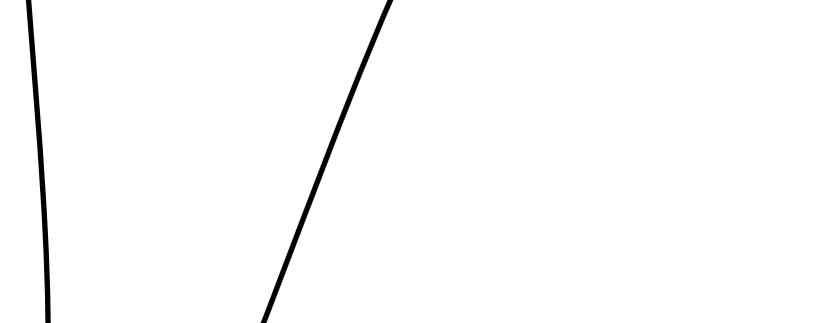
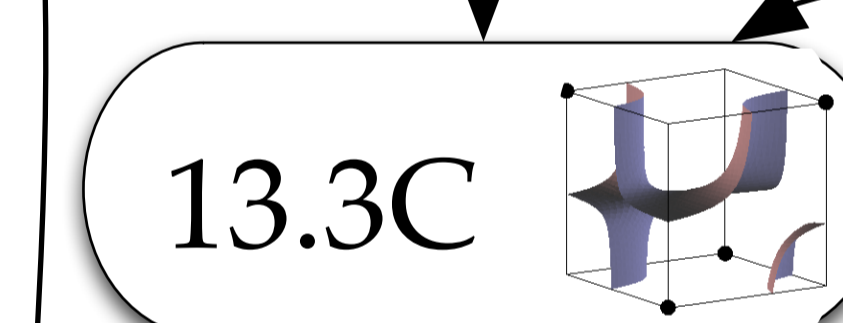
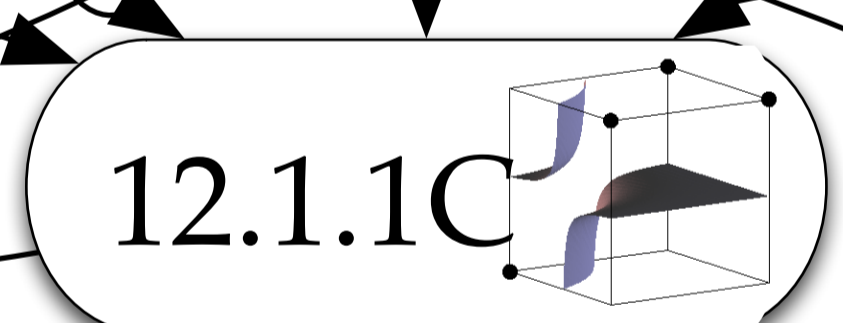
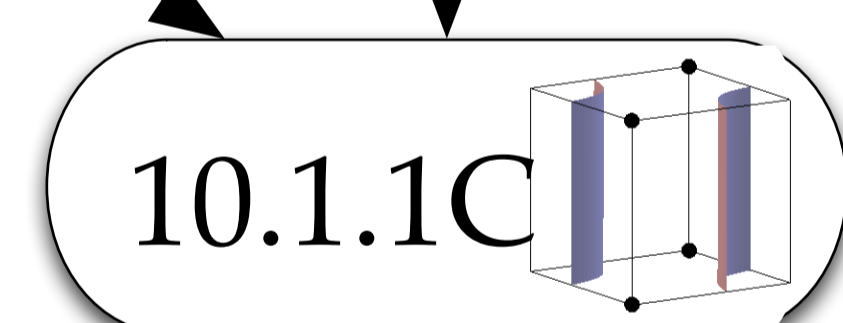
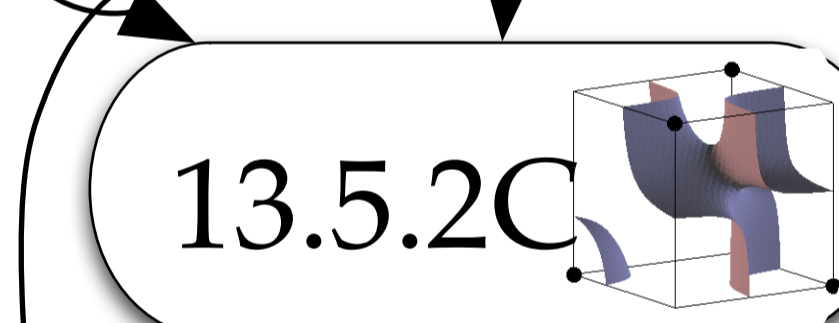
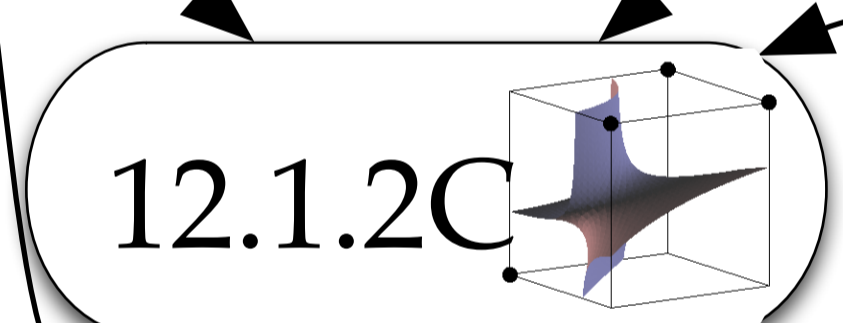
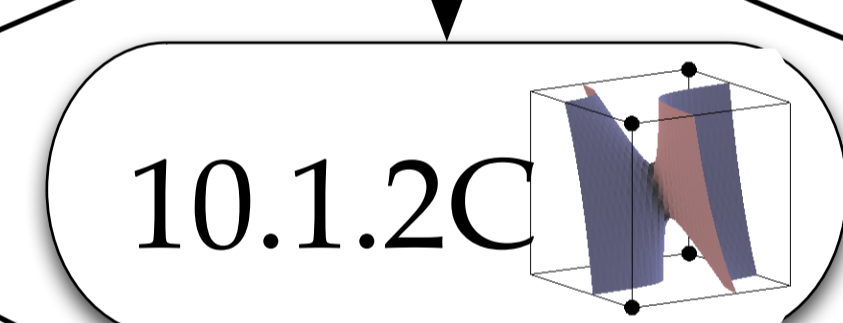
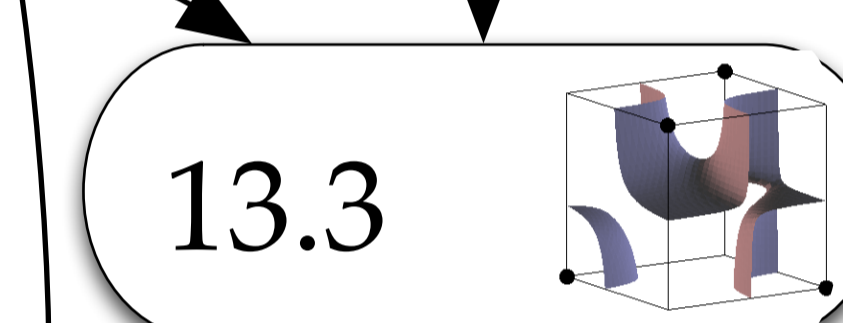
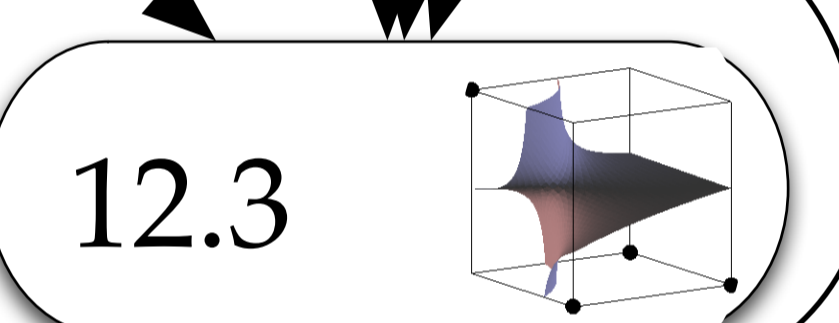
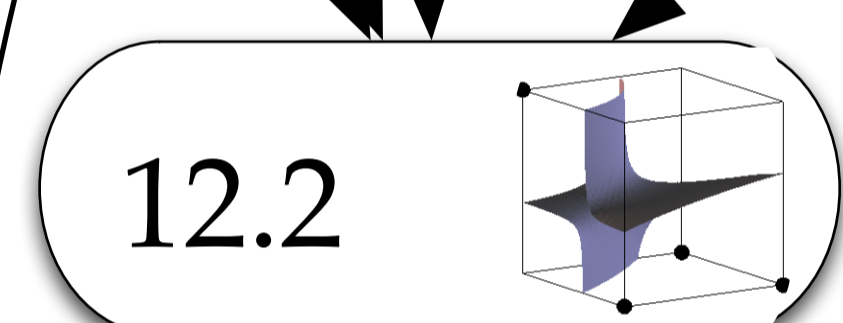
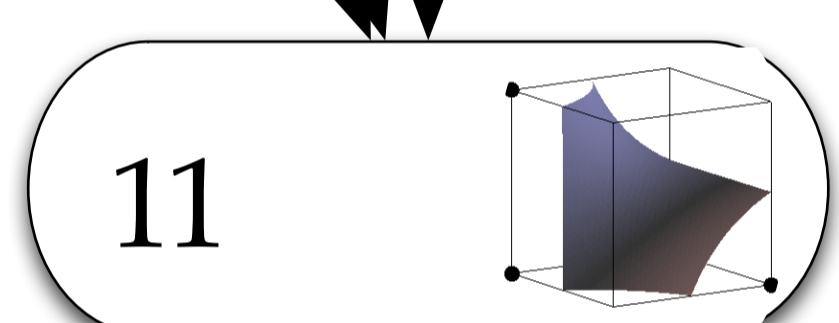
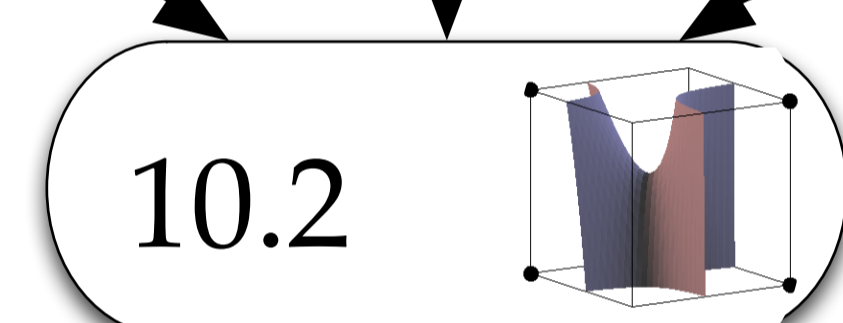

6 Vertices Above Isosurface

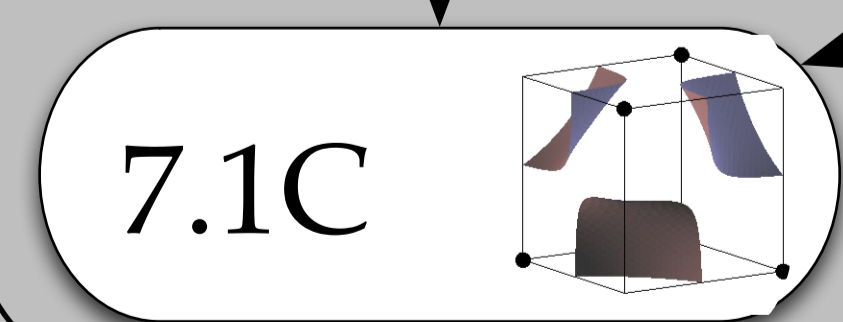
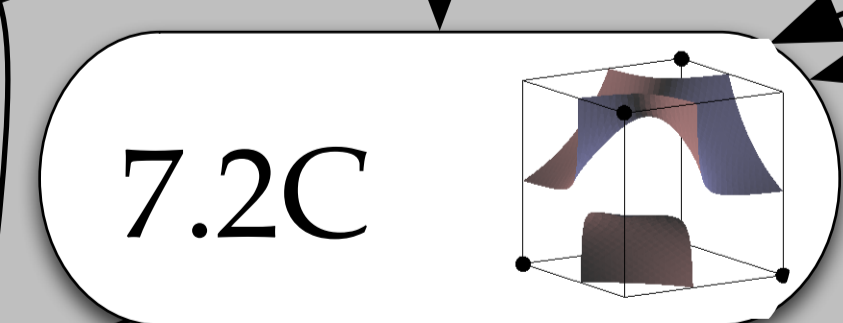
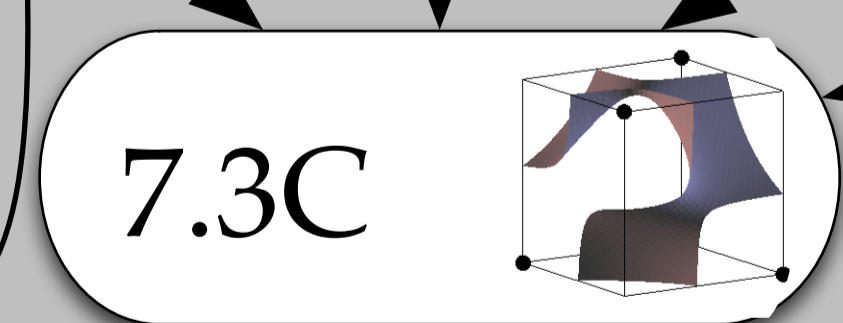
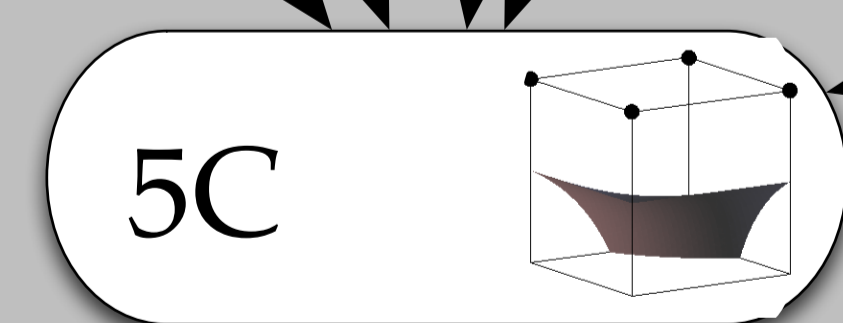
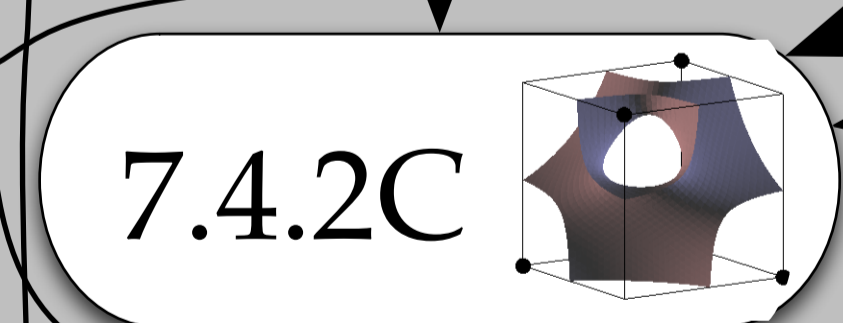
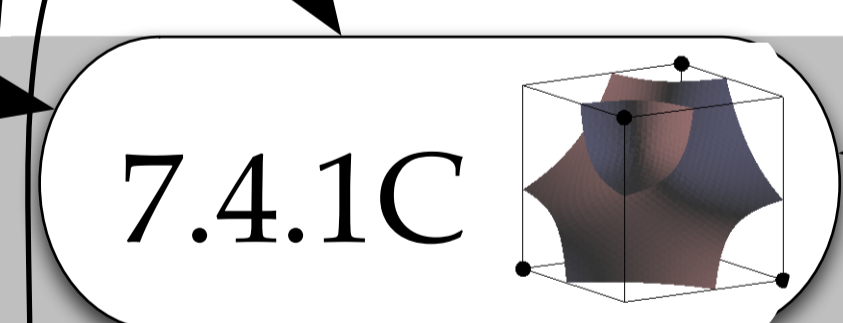
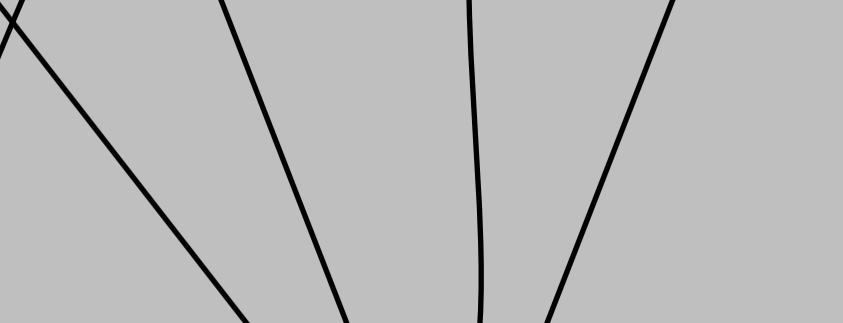

7 Vertices Above Isosurface

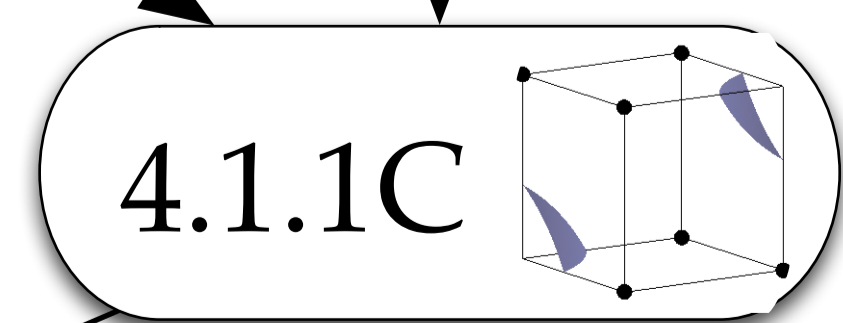
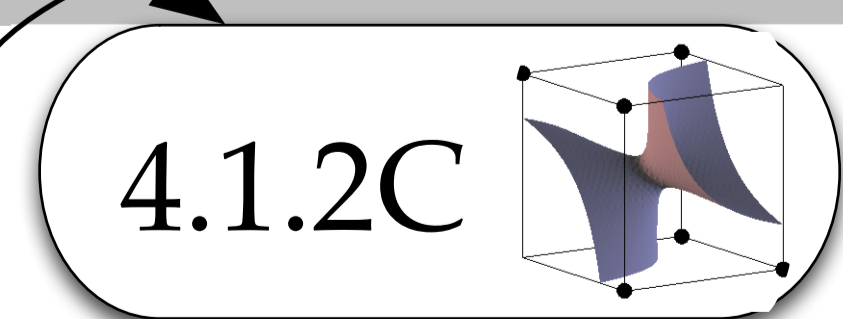
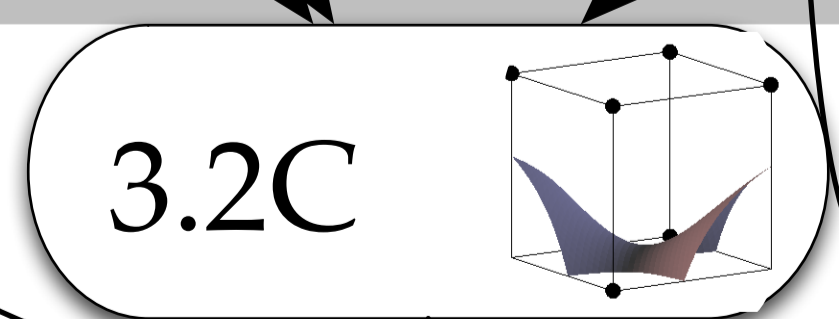
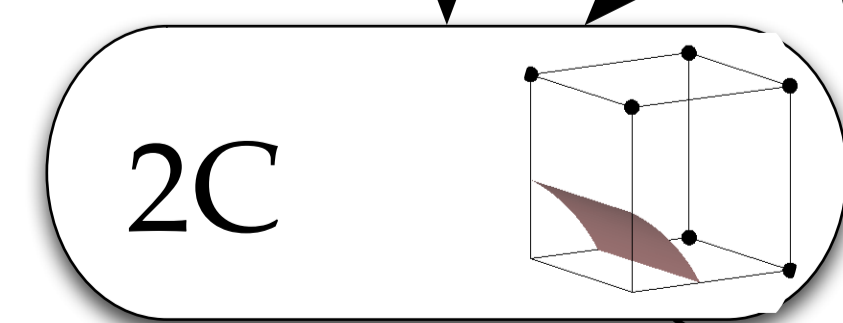

8 Vertices Above Isosurface

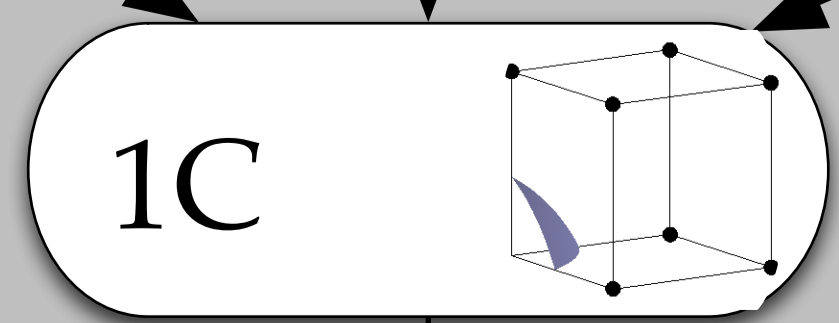

8 Vertices Above Isosurface

